

STAMFORD®

S5L1M-D4 Wdg.311 - Technical Data Sheet

Standards

STAMFORD industrial alternators meet the requirements of the relevant parts of the IEC 60034 and the relevant sections of other international standards such as BS5000-3, ISO 8528-3, VDE 0530, NEMA MG1-32, CSA C22.2-100 and AS 60034. Other standards and certifications can be considered on request.

Quality Assurance

Alternators are manufactured using production procedures having a quality assurance level to BS EN ISO 9001.

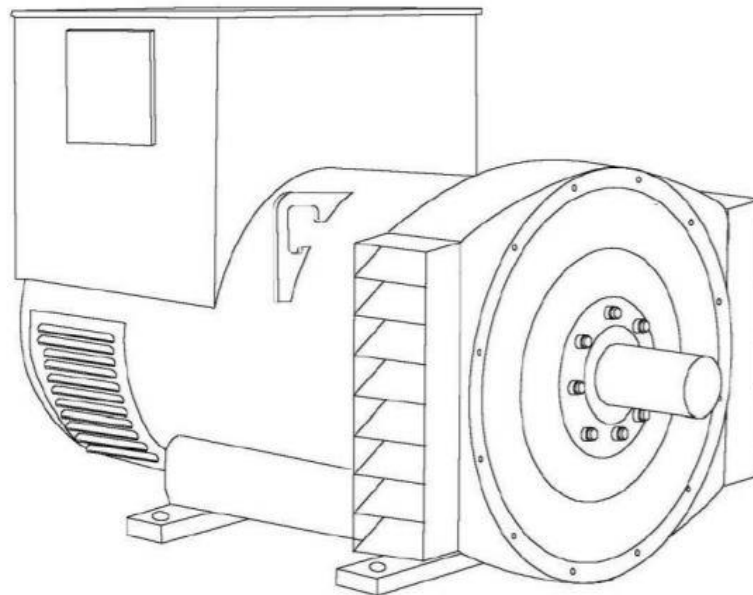

Excitation and Voltage Regulators

Excitation System					
AVR Type	MX341	MX321	MX322		
Voltage Regulation	± 1%	± 0.5%	± 0.5%		with 4% Engine Governing
AVR Power	PMG	PMG	PMG		

No Load Excitation Voltage (V)	9.5 - 8.7
No Load Excitation Current (A)	0.6 - 0.55
Full Load Excitation Voltage (V)	38.2 - 35.2
Full Load Excitation Current (A)	2.4 - 2.2
Exciter Time Constant (seconds)	0.099

STAMFORD

S5L1M-D4 Wdg.311

Electrical Data								
Insulation System	H							
Stator Winding	Double Layer Lap							
Winding Pitch	2/3							
Winding Leads	12							
Winding Number	311							
Number of Poles	4							
IP Rating	IP23							
RFI Suppression	BS EN 61000-6-2 & BS EN 61000-6-4, VDE 0875G, VDE 0875N. Refer to factory for others							
Waveform Distortion	NO LOAD < 1.5% NON-DISTORTING BALANCED LINEAR LOAD < 5.0%							
Short Circuit Ratio	1/Xd							
Steady State X/R Ratio	15.69							
	50 Hz				60 Hz			
Telephone Interference	THF<2%				TIF<50			
Cooling Air Flow	1.035 m³/sec				1.312 m³/sec			
Voltage Series Star (V)	380	400	415	440	416	440	460	480
Voltage Parallel Star (V)	190	200	208	220	208	220	230	240
Voltage Series Delta (V)	220	230	240	254	240	254	266	277
kVA Base Rating (Class H) for Reactance Values (kVA)	435	435	435	435	500	520	545	570
Saturated Values in Per Unit at Base Ratings and Voltages								
Xd Dir. Axis Synchronous	2.63	2.37	2.20	1.96	3.02	2.81	2.69	2.59
X'd Dir. Axis Transient	0.13	0.12	0.11	0.10	0.15	0.14	0.14	0.13
X''d Dir. Axis Subtransient	0.10	0.09	0.08	0.07	0.11	0.11	0.10	0.10
Xq Quad. Axis Reactance	2.16	1.95	1.81	1.61	2.49	2.31	2.22	2.13
X''q Quad. Axis Subtransient	0.24	0.22	0.20	0.18	0.28	0.26	0.25	0.24
XL Stator Leakage Reactance	0.03	0.03	0.03	0.02	0.04	0.04	0.03	0.03
X2 Negative Sequence Reactance	0.17	0.15	0.14	0.12	0.19	0.18	0.17	0.16
X0 Zero Sequence Reactance	0.09	0.08	0.07	0.07	0.10	0.09	0.09	0.09
Unsaturated Values in Per Unit at Base Ratings and Voltages								
Xd Dir. Axis Synchronous	3.15	2.84	2.64	2.35	3.63	3.37	3.23	3.11
X'd Dir. Axis Transient	0.15	0.14	0.13	0.11	0.18	0.16	0.16	0.15
X''d Dir. Axis Subtransient	0.12	0.11	0.10	0.09	0.13	0.12	0.12	0.11
Xq Quad. Axis Reactance	2.23	2.01	1.87	1.66	2.56	2.38	2.28	2.19
X''q Quad. Axis Subtransient	0.29	0.26	0.25	0.22	0.34	0.31	0.30	0.29
XL Stator Leakage Reactance	0.04	0.03	0.03	0.03	0.04	0.04	0.04	0.04
Xlr Rotor Leakage Reactance	0.08	0.07	0.07	0.06	0.09	0.08	0.08	0.08
X2 Negative Sequence Reactance	0.20	0.18	0.17	0.15	0.23	0.21	0.20	0.20
X0 Zero Sequence Reactance	0.10	0.09	0.09	0.08	0.12	0.11	0.11	0.10

STAMFORD

S5L1M-D4 Wdg.311

Time Constants (Seconds)		
T'd Transient Time Const.	0.080	
T''d Sub-Transient Time Const.	0.012	
T'do O.C. Field Time Const.	2.200	
Ta Armature Time Const.	0.018	
T''q Sub-Transient Time Const.	0.0190	
Resistances in Ohms (Ω) at 22°C		
Stator Winding Resistance (Ra), per phase for series connected	0.00490	
Rotor Winding Resistance (Rf)	1.77	
Exciter Stator Winding Resistance	17	
Exciter Rotor Winding Resistance per phase	0.092	
PMG Phase Resistance (Rpmg) per phase	1.9	
Positive Sequence Resistance (R1)	0.0061	
Negative Sequence Resistance (R2)	0.0071	
Zero Sequence Resistance (R0)	0.0061	
Saturation Factors	400V	480V
SG1.0	0.361	0.365
SG1.2	1.461	1.309
Mechanical Data		
Shaft and Keys	All alternator rotors are dynamically balanced to better than ISO 21940-11 Grade 2.5 for minimum vibration in operation. Two bearing generators are balanced with a half key.	
	1 Bearing	2 Bearing
SAE Adaptor	SAE 00, 0, 0.5, 1	SAE 00, 0, 0.5, 1
Moment of Inertia	8.0068 kgm ²	7.7289 kgm ²
Weight Wound Stator	657kg	657kg
Weight Wound Rotor	563kg	535kg
Weight Complete Alternator	1393kg	1395kg
Shipping weight in a Crate	1485kg	1485kg
Packing Crate Size	166x87x124(cm)	166x87x124(cm)
Maximum Over Speed	2250 RPM for two minutes	
Bearing Drive End	-	BALL.6220(ISO)
Bearing Non-Drive End	BALL.6314(ISO)	BALL.6314(ISO)

STAMFORD

S5L1M-D4 Wdg.311

THREE PHASE EFFICIENCY CURVES

50Hz

60Hz

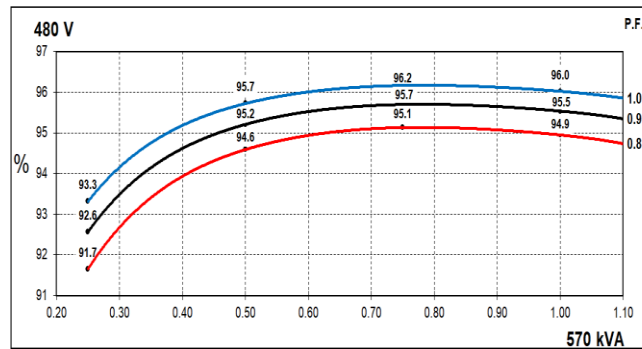
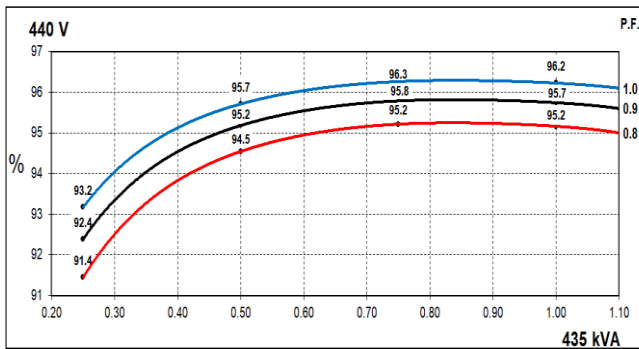
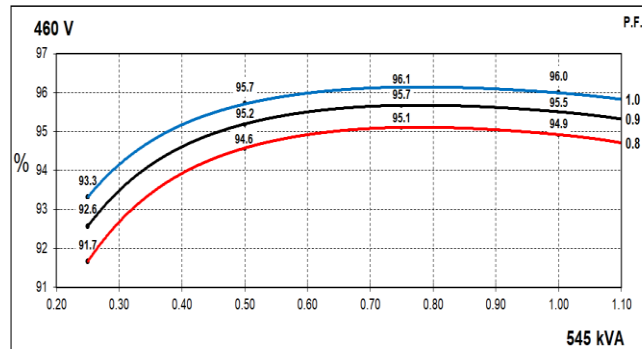
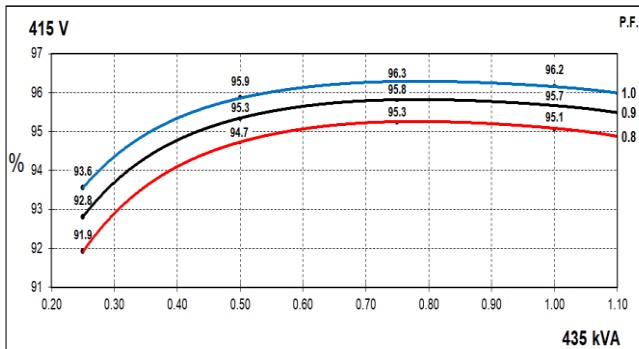
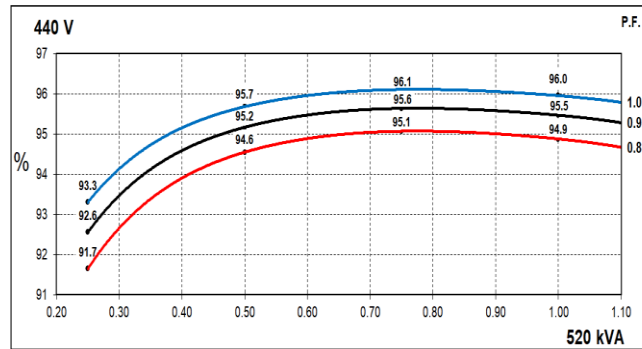
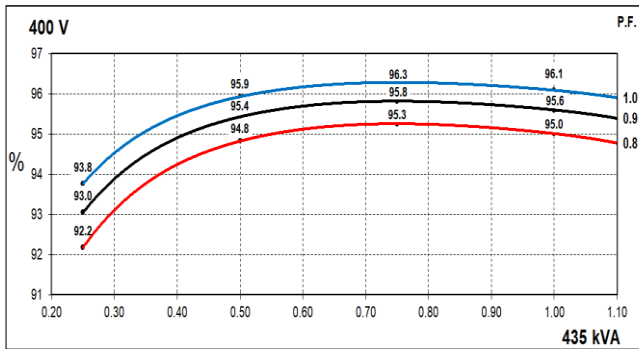
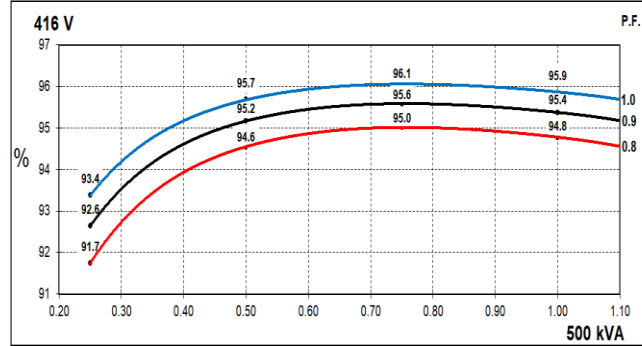
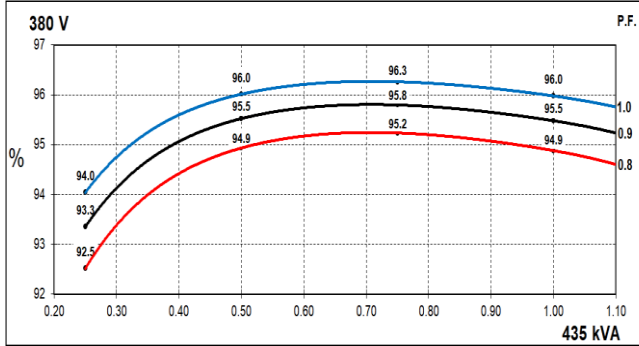

STAMFORD

S5L1M-D4 Wdg.311

Locked Rotor Motor Starting Curves - Separately Excited

50Hz

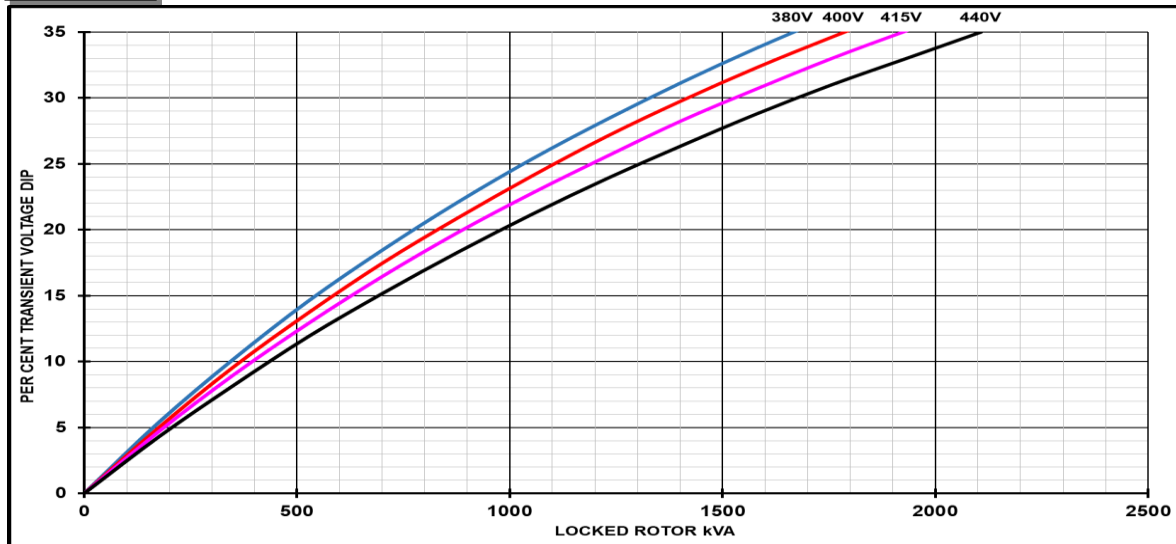

60Hz

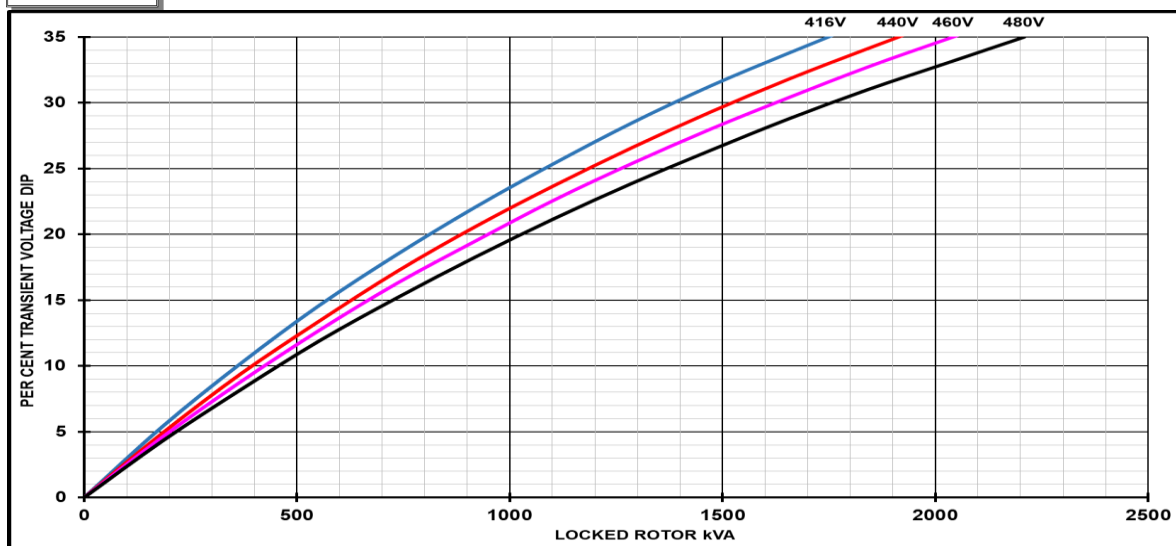

Transient Voltage Dip Scaling Factor		Transient Voltage Rise Scaling Factor	
Lagging PF	Scaling Factor	Lagging PF	Scaling Factor
<= 0.4	1.00	<= 0.4	1.25
0.5	0.95	0.5	1.20
0.6	0.90	0.6	1.15
0.7	0.86	0.7	1.10
0.8	0.83	> 0.7	1.00
0.9	0.75		
0.95	0.70		
1	0.65		

Note: To determine % Transient Voltage Dip or Voltage Rise at various PF, multiply the % Voltage Dip from the curve directly by the Scaling Factor.

STAMFORD®

S5L1M-D4 Wdg.311

Three-phase Short Circuit Decrement Curve - Separately Excited

50Hz

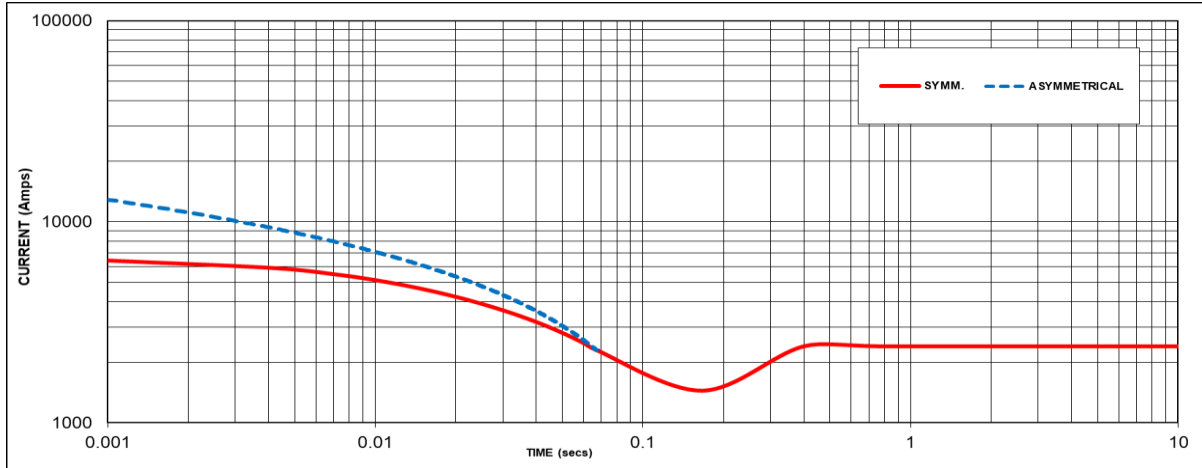

Sustained Short Circuit = 2400 Amps

60Hz

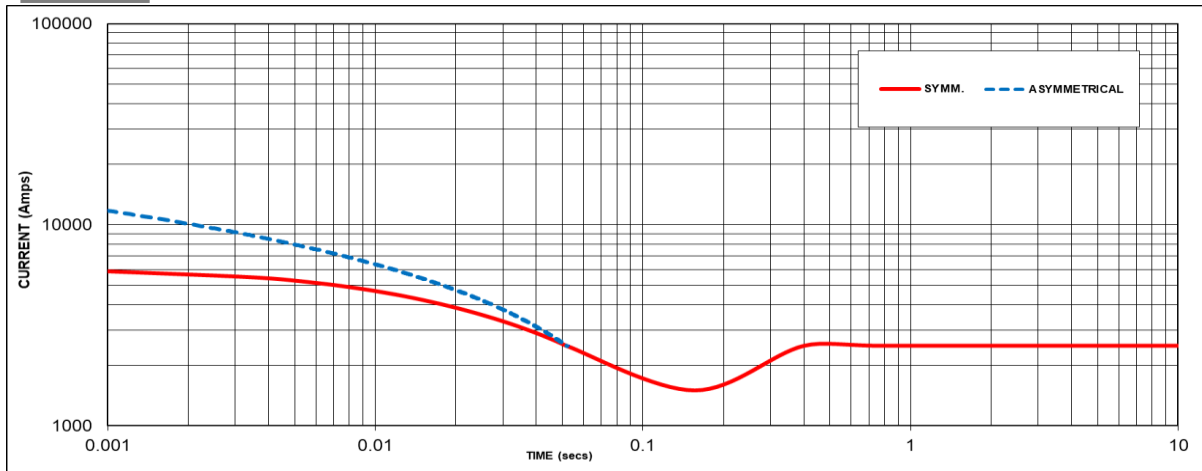

Sustained Short Circuit = 2500 Amps

Note 1

The following multiplication factors should be used to adjust the values from curve between time 0.001 seconds and the minimum current point in respect of nominal operating voltage :

50Hz		60Hz	
Voltage	Factor	Voltage	Factor
380V	X 1.00	416V	X 1.00
400V	X 1.05	440V	X 1.06
415V	X 1.09	460V	X 1.10
440V	X 1.16	480V	X 1.15

The sustained current value is constant irrespective of voltage level

If MX322 or digital AVR is used, the sustained short-circuit current value is to be multiplied by a factor of 1.1.

Note 2

The following multiplication factor should be used to convert the values calculated in accordance with NOTE 1 to those applicable to the various types of short circuit :

	3-phase	2-phase L-L	1-phase L-N
Instantaneous	x 1.00	x 0.87	x 1.30
Minimum	x 1.00	x 1.80	x 3.20
Sustained	x 1.00	x 1.50	x 2.50
Max. sustained duration	10 sec.	5 sec.	2 sec.

Note 3

All other times are unchanged
 Curves are drawn for Star connections under no-load excitation at rated speeds. For other connection (where applicable) the following multipliers should be applied to current values as shown :
 Parallel Star = Curve current value X 2
 Series Delta = Curve current value X 1.732

STAMFORD

S5L1M-D4 Wdg.311

Typical Alternator Operating Charts

400V/50Hz

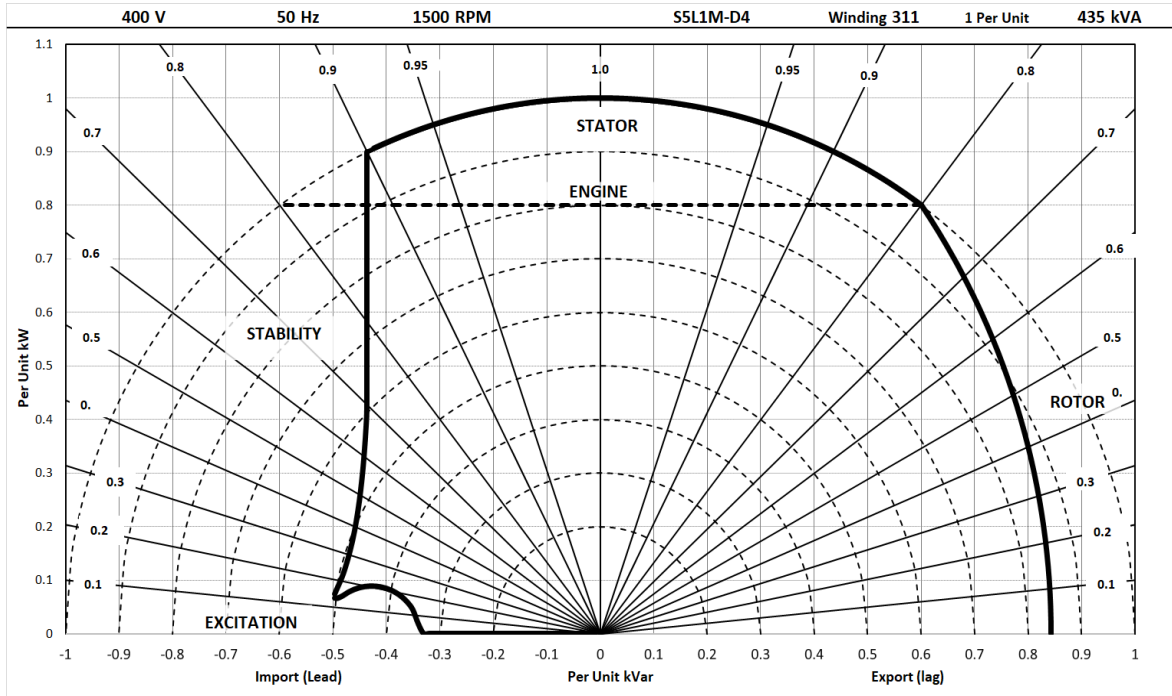

480V/60Hz

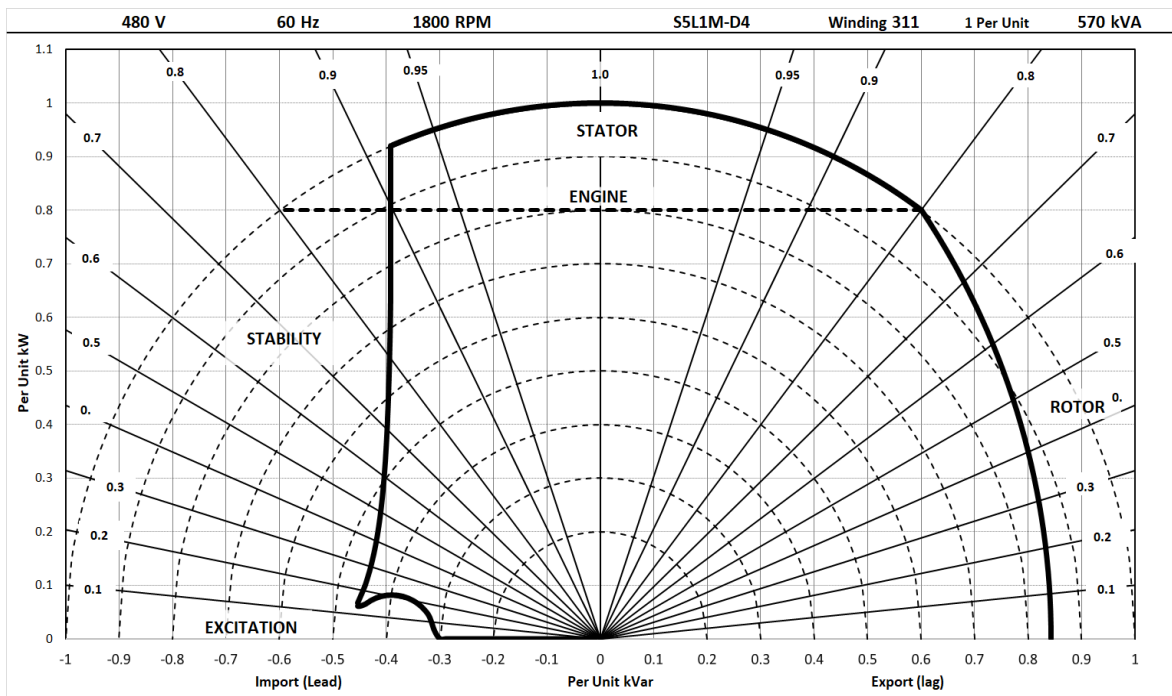

STAMFORD®

S5L1M-D4 Wdg.311

RATINGS AT 0.8 POWER FACTOR

Class - Temp Rise		Standby				Cont. H - 110/50°C				Cont. F - 90/50°C				Cont. B - 70/50°C			
50 Hz	Series Star (V)	380	400	415	440	380	400	415	440	380	400	415	440	380	400	415	440
	Parallel Star (V)	190	200	208	220	190	200	208	220	190	200	208	220	190	200	208	220
	Series Delta (V)	220	230	240	254	220	230	240	254	220	230	240	254	220	230	240	254
	kVA	N/A	N/A	N/A	N/A	435	435	435	435	405	415	430	430	355	365	375	375
	kW	N/A	N/A	N/A	N/A	348	348	348	348	324	332	344	344	284	292	300	300
	Efficiency (%)	N/A	N/A	N/A	N/A	94.9	95.0	95.1	95.2	95.0	95.1	95.1	95.2	95.2	95.2	95.2	95.3
	kW Input	N/A	N/A	N/A	N/A	367	366	366	366	341	349	362	361	298	307	315	315

60 Hz	Series Star (V)	416	440	460	480	416	440	460	480	416	440	460	480	416	440	460	480
	Parallel Star (V)	208	220	230	240	208	220	230	240	208	220	230	240	208	220	230	240
	Series Delta (V)	240	254	266	277	240	254	266	277	240	254	266	277	240	254	266	277
	kVA	N/A	N/A	N/A	N/A	500	520	545	570	463	488	506	531	405	425	445	465
	kW	N/A	N/A	N/A	N/A	400	416	436	456	370	390	405	425	324	340	356	372
	Efficiency (%)	N/A	N/A	N/A	N/A	94.8	94.9	94.9	94.9	94.9	95.0	95.0	95.0	95.0	95.1	95.1	95.1
	kW Input	N/A	N/A	N/A	N/A	422	438	459	480	390	411	426	447	341	358	374	391

De-rates

All values tabulated above are subject to the following reductions:

- 5% when air inlet filters are fitted
- 3% for every 500 meters by which the operating altitude exceeds 1000 meters above mean sea level
- 3% for every 5°C by which the operational ambient temperature exceeds 40°C @ Class H temperature rise (please refer to applications for ambient temperature de-rates at other temperature rise classes)
- For any other operating conditions impacting the cooling circuit please refer to applications

Note: Requirement for operating in an ambient exceeding 60°C and altitude exceeding 4000 meters (for <690V) or 1500 meters (for >690V) must be referred to applications.

Dimensional and Torsional Drawing

For dimensional and torsional information please refer to the alternator General Arrangement and rotor drawings available on our website (<http://stamford-avk.com/>)

Note: Continuous development of our products means that the information contained in our data sheets can change without notice, and specifications should always be confirmed with Cummins Generator Technologies prior to purchase.



Follow us @stamfordavk



Cummins Generator Technologies



View our videos at youtube.com/stamfordavk

stamford-avk.com

**For Applications Support:
applications@cummins.com**

**For Customer Service:
emea.service@cummins.com**

**For General Enquiries:
Stamford-avk@cummins.com**

Copyright 2020. Cummins Generator Technologies Ltd. All rights reserved.
Cummins and the Cummins logo are registered trade marks of Cummins Inc.
STAMFORD is a registered trade mark of Cummins Generator Technologies Ltd.

